

Huawei.H12-811.v2021-10-28.q161

Exam Code:	H12-811
Exam Name:	HCIA-Datacom V1.0
Certification Provider:	Huawei
Free Question Number:	161
Version:	v2021-10-28
# of views:	4355
# of Questions views:	1610
https://www.freepdfdumps.com/Huawei.H12-811.v2021-10-28.q161.html	

NEW QUESTION: 1

The Layer 2 Ethernet switch generates entries in the MAC address table according to the () of the Ethernet frame received by the port.

- A. Source MAC address
- B. Destination IP address
- C. Destination MAC address
- D. Source IP address

Answer: A ([LEAVE A REPLY](#))

NEW QUESTION: 2

NFV (Network Functional Virtualization), network function virtualization realizes the deployment of network applications in a software-based way.

- A. True
- B. False

Answer: A ([LEAVE A REPLY](#))

NEW QUESTION: 3

As shown in the figure below, host A and host B cannot communicate.



A. True

B. False

Answer: B ([LEAVE A REPLY](#))

NEW QUESTION: 4

In the network shown in the figure below, which of the following commands can be entered on the router to enable host A to ping host B? (Multiple choice)

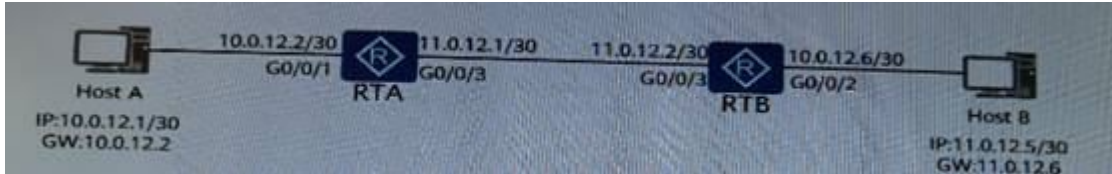

A. RTA: ip route-static 10.0.12.5 255.255.255.252 11.0.12.2 RTB: ip route-static 10.0.12.1 255.255.255.252 11.0.12.1

B. RTA: ip route-static 0.0.0.0 0.0.0.0 11.0.12.1 RTB: ip route-static 0.0.0.0 0.0.0.0 11.0.12.2

C. RTA: ip route-static 10.0.12.5 255.255.255.252 11.0.12.1 RTB: ip route-static 10.0.12.1 255.255.255.252 11.0.12.2

D. RTA: ip route-static 0.0.0.0 0.0.0.0 11.0.12.2 RTB: ip route-static 0.0.0.0 0.0.0.0 11.0.12.1

Answer: A,D ([LEAVE A REPLY](#))

NEW QUESTION: 5

Which of the following statement about the main functions of the router is wrong? (Multiple choice)

A. Forwarding according to the source IP address of the received data packet

B. Guide data forwarding according to the routing table

C. Realize the mutual communication between the same network disconnection equipment

D. Establish routing tables through multiple protocols

Answer: A,B,C ([LEAVE A REPLY](#))

NEW QUESTION: 6

Which of the following does not include the advantages of Wi-Fi 6 compared to Wi-Fi 5?

A. Lower transmission delay

B. Higher power consumption

C. Higher bandwidth

D. Higher number of access terminals per AP

Answer: B ([LEAVE A REPLY](#))

NEW QUESTION: 7

UDP cannot guarantee the reliability of data transmission, and does not provide the functions of message sequencing and flow control. It is suitable for flows with low transmission reliability requirements but high transmission speed and delay requirements.

A. True

B. False

Answer: ([SHOW ANSWER](#))

NEW QUESTION: 8

All ports on the root bridge switch are designated ports.

- A. False
- B. True

Answer: B ([LEAVE A REPLY](#))

NEW QUESTION: 9

Which version of the SNMP protocol below supports encryption features?

- A. SNMPv2
- B. SNMPv1
- C. SNMPv2c
- D. SNMPv3

Answer: D ([LEAVE A REPLY](#))

NEW QUESTION: 10

In what state does the OSPF protocol determine the master-slave relationship of DD packets?

- A. Full
- B. ExStart
- C. Exchange
- D. 2-way

Answer: D ([LEAVE A REPLY](#))

NEW QUESTION: 11

Before the STA associates with the AP, it needs to exchange some messages to obtain the SSID. What are these messages?

- A. Beacon
- B. Discovery
- C. ResponseProbe Request
- D. Probe

Answer: C ([LEAVE A REPLY](#))

NEW QUESTION: 12

As shown in the following figure, router A and router B establish an OSPF neighbor relationship. The OSPF process number of router A is 1, and the area number is 0. Which of the following configurations on router A can enable router B to obtain the network segment of host A routing? (Multiple choice)



- A. ospf 1 Area 0.0.0.0 Network 192.168.1.2 0.0.0.0
- B. ospf 1 Area 0.0.0.0 Network 192.168.1.0 0.0.0.255
- C. ospf 1 Area 0.0.0.0 Network 192.168.0.0 0.0.255.255
- D. ospf 1 Import-route direct

Answer: B,C,D (LEAVE A REPLY)

NEW QUESTION: 13

Both pwd and dir commands in the VRP operating platform can view the file information under the current directory.

- A. TURE
- B. FALSE

Answer: B (LEAVE A REPLY)

NEW QUESTION: 14

The broadcast address is a special address in which the host bits in the network address are all set to 1, and it can also be used as a host address.

- A. False
- B. True

Answer: A (LEAVE A REPLY)

NEW QUESTION: 15

On Huawei ARG3 series routers, what authentication modes does AAA support? (Multiple Choice)

- A. Local
- B. None
- C. HWTACACS
- D. 802.1x

Answer: A,B,C (LEAVE A REPLY)

NEW QUESTION: 16

Compared with STP, which of the following port roles are newly defined in RSTP? (Multiple choice)

- A. Backup port
- B. Root port
- C. Designated port
- D. Alternate port

Answer: A,D ([LEAVE A REPLY](#))

Valid H12-811 Dumps shared by Actual4test.com for Helping Passing H12-811 Exam! Actual4test.com now offer the **newest H12-811 exam dumps**, the Actual4test.com H12-811 exam **questions have been updated** and **answers have been corrected** get the **newest** Actual4test.com H12-811 dumps with Test Engine here:

https://www.actual4test.com/H12-811_examcollection.html (732 Q&As Dumps, **30%OFF**

Special Discount: [Freepdfdumps](#))

NEW QUESTION: 17

By default, what is the STP Forward Delay time in seconds?

- A. 10
- B. 15
- C. 20
- D. 5

Answer: B ([LEAVE A REPLY](#))

NEW QUESTION: 18

Which of the following description about the Router ID of OSPF is incorrect? (Multiple Choice)

- A. The Router ID must be manually configured
- B. The Router ID must be the same in the same area, and the Router ID in different areas can be different
- C. The prerequisite for the normal operation of the OSPF protocol is that the router has a Router ID
- D. Router ID must be the IP address of an interface on the router

Answer: A,B,C,D ([LEAVE A REPLY](#))

NEW QUESTION: 19

Which of the following statement about static routing is wrong?

- A. Cannot automatically adapt to changes in network topology
- B. Low system performance requirements
- C. Routers need to exchange routing information
- D. Manual configuration by the network administrator

Answer: ([SHOW ANSWER](#))

NEW QUESTION: 20

The router running the OSPF protocol can reach the FULL state after completing the LSDB synchronization.

- A. False
- B. True

Answer: B ([LEAVE A REPLY](#))

NEW QUESTION: 21

When the router forwards a data packet, if it does not match the corresponding detailed route and there is no default route, it will directly discard the data packet.

- A. True
- B. False

Answer: A ([LEAVE A REPLY](#))

NEW QUESTION: 22

In which working state of the STP protocol can the port be changed to the Forwarding state without going through other states?

- A. Blocking
- B. Learning
- C. Listening
- D. Disabled

Answer: B ([LEAVE A REPLY](#))

NEW QUESTION: 23

When the IPv4 protocol is used as the network layer protocol, which field is not included in the network layer header?

- A. Source IPv4 address
- B. TTL
- C. Sequence number
- D. Destination IPv4 address

Answer: C ([LEAVE A REPLY](#))

NEW QUESTION: 24

Which of the following statements about RA and RS in IPv6 are correct? (Multiple Choice)

- A. RS is used to request address prefix information
- B. RA is used to request address prefix information
- C. RS is used to reply address prefix information
- D. RA is used to reply address prefix information

Answer: ([SHOW ANSWER](#))

NEW QUESTION: 25

After the link authentication is completed, the STA will continue to initiate link service negotiation. Which of the following messages is used to achieve the specific negotiation?

- A. Association
- B. Join
- C. Handshake
- D. Negotiate

Answer: D ([LEAVE A REPLY](#))

NEW QUESTION: 26

The administrator plans to implement route backup by configuring static floating routes, what is the correct way to achieve this?

- A. The administrator needs to configure different TAGs for the main static route and the standby static route
- B. The administrator needs to configure different metric values for the main static route and the standby static route
- C. The administrator only needs to configure two static routes
- D. The administrator needs to configure different protocol priority values for the main static route and the standby static route

Answer: (SHOW ANSWER)

NEW QUESTION: 27

If a windows host is started for the first time, if the IP address is obtained by DHCP, then what is the source IP address of the first packet sent by this host?

- A. 255.255.255.255
- B. 169.254.2.33
- C. 127.0.0.1
- D. 0.0.0.0

Answer: (SHOW ANSWER)

NEW QUESTION: 28

The picture shows the display startup information of AR2200 router. Regarding these information, which of the following statement is wrong?

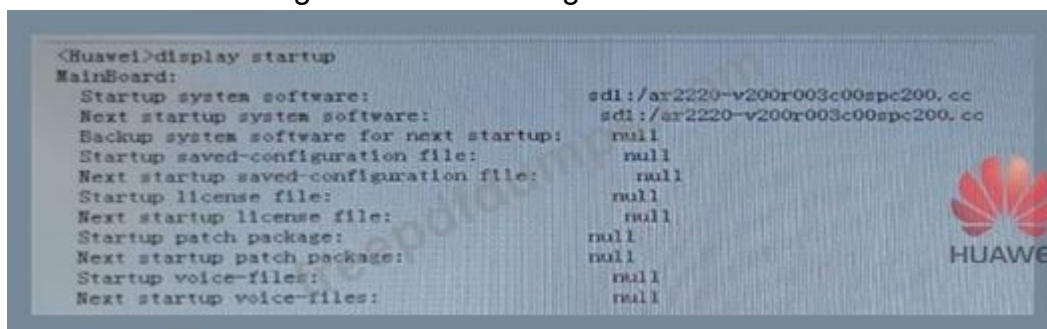

```
<Huawei>display startup
MainBoard:
  Startup system software:          sdi:/ar2220-v200r003c00spc200.cc
  Next startup system software:     sdi:/ar2220-v200r003c00spc200.cc
  Backup system software for next startup:  null
  Startup saved-configuration file:      null
  Next startup saved-configuration file:   null
  Startup license file:              null
  Next startup license file:          null
  Startup patch package:             null
  Next startup patch package:         null
  Startup voice-files:               null
  Next startup voice-files:          null
```

The screenshot shows the output of the 'display startup' command on a Huawei AR2200 router. The output lists various startup parameters and their values. A large 'Copyright' watermark is visible across the terminal output. The Huawei logo is present in the bottom right corner of the terminal window.

- A. The system file used by the device this time is ar2220-v200r003c00spc00.cc
- B. next system startup file system can use the command "startup system software <startup-software-name>" to modify
- C. The system file cannot be modified when the device is started next time
- D. The running configuration file is not saved

Answer: C ([LEAVE A REPLY](#))

NEW QUESTION: 29

When the router is powered on, it will read the configuration file from the default storage path to initialize the router. If there is no configuration file in the default storage path, what will the router use for initialization?

- A. Initial configuration
- B. New configuration
- C. Default parameters
- D. Current configuration

Answer: C ([LEAVE A REPLY](#))

NEW QUESTION: 30

In the network shown in the figure below, assuming that all routers enable the OSPF protocol at the same time, which router is the BDR in this network?

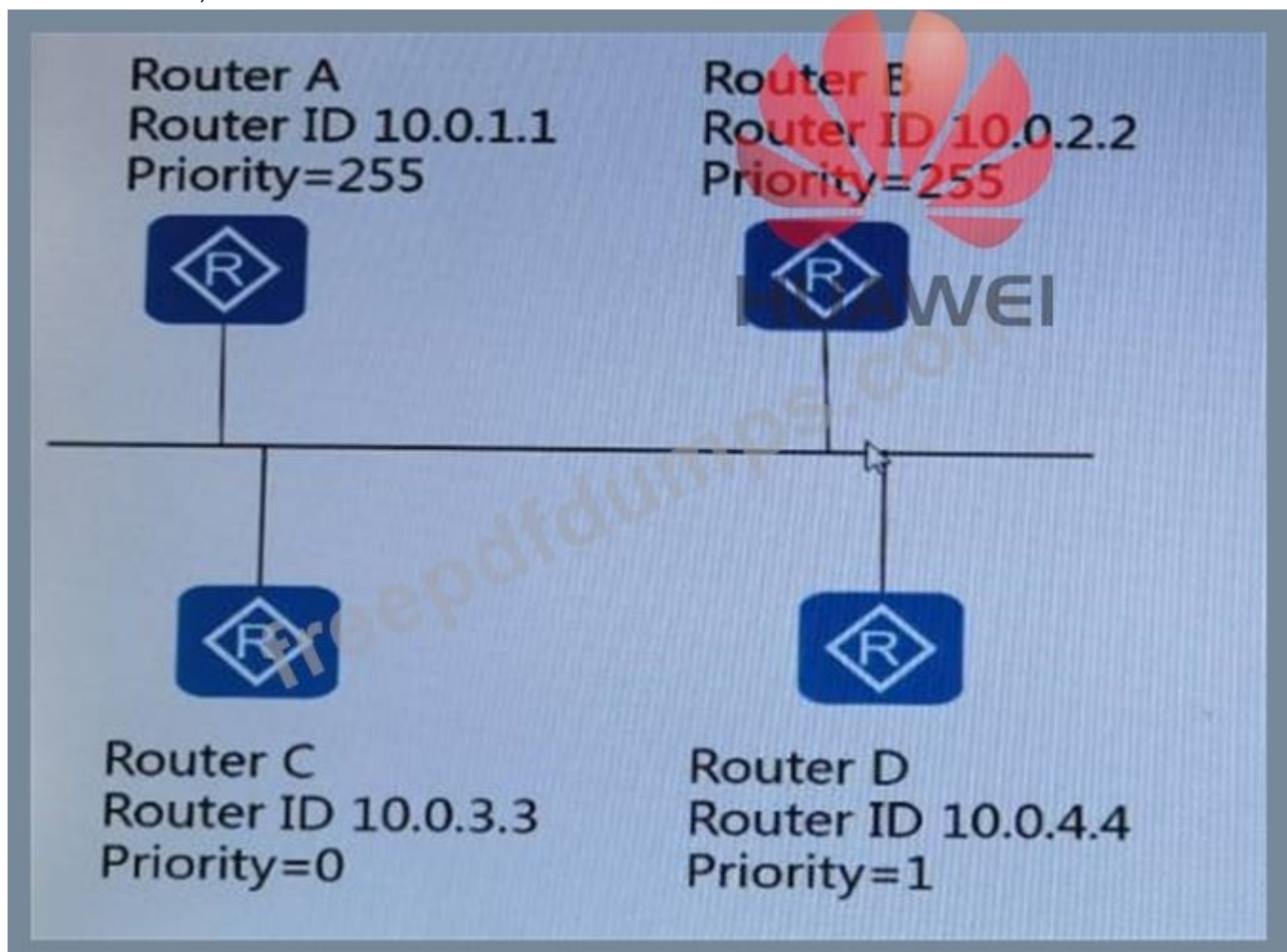

- A. Router C
- B. Router A
- C. Router D
- D. Router B

Answer: B ([LEAVE A REPLY](#))

NEW QUESTION: 31

Which of the following does not be included in AAA?

- A. Authentication
- B. Authorization
- C. Accounting
- D. Audit

Answer: D ([LEAVE A REPLY](#))

Valid H12-811 Dumps shared by Actual4test.com for Helping Passing H12-811 Exam!
Actual4test.com now offer the **newest H12-811 exam dumps**, the Actual4test.com H12-811 exam **questions have been updated** and **answers have been corrected** get the **newest** Actual4test.com H12-811 dumps with Test Engine here:

https://www.actual4test.com/H12-811_examcollection.html (732 Q&As Dumps, **30%OFF**)

Special Discount: Freepdfdumps)

NEW QUESTION: 32

In the WLAN network architecture, what is terminal equipment that supports the 802.11 standard called?

- A. Client
- B. AP
- C. STA
- D. AC

Answer: C ([LEAVE A REPLY](#))

NEW QUESTION: 33

As shown in the figure below, which port of the following switches will be blocked?

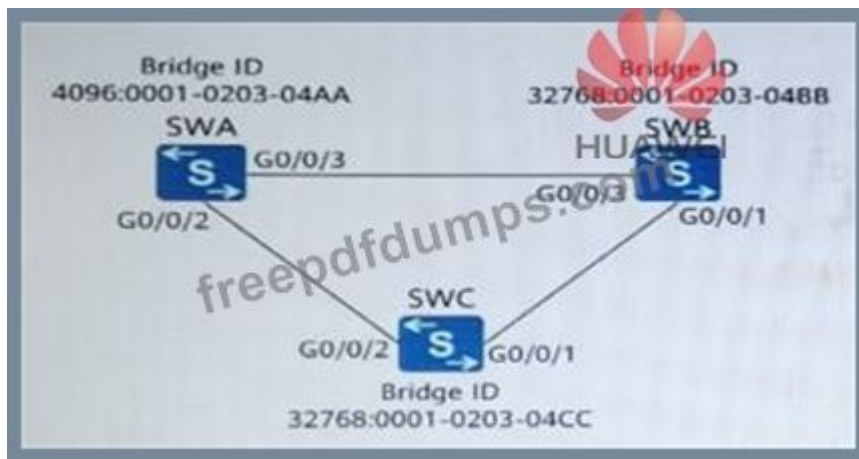

- A. SWA G0/0/3
- B. SWC G0/0/1
- C. SWB G0/0/3
- D. SWC G0/0/2

Answer: B ([LEAVE A REPLY](#))

NEW QUESTION: 34

What type of IPv6 address FE80: 2E0: FCFF: FE6F: 4F36 belongs to?

- A. Anycast address
- B. Link local address
- C. Global semicast address
- D. Multicast address

Answer: ([SHOW ANSWER](#)**)**

NEW QUESTION: 35

Which of the following statements about direct routing is correct?

- A. Direct routing requires the administrator to manually configure the destination network and the next-hop address
- B. Direct route priority is lower than dynamic route
- C. Direct route has lower priority than static route
- D. Direct routing has the highest priority

Answer: D ([LEAVE A REPLY](#))

NEW QUESTION: 36

Link aggregation is a common technology in enterprise networks. Which of the following descriptions are the advantages of link aggregation technology? (Multiple Choice)

- A. Improve reliability
- B. Realize load sharing
- C. Increase bandwidth
- D. Improve safety

Answer: A,B,C ([LEAVE A REPLY](#))

NEW QUESTION: 37

Neither the Alternate interface nor the Backup port in RSTP can forward user traffic, nor can they receive, process, and forward BPDUs.

- A. True
- B. False

Answer: B ([LEAVE A REPLY](#))

NEW QUESTION: 38

The network administrator uses Ping to test the connectivity of the network. Which of the following protocols may be used in this process? (Multiple choice)

- A. ARP
- B. TCP
- C. UDP
- D. ICMP

Answer: ([SHOW ANSWER](#))

NEW QUESTION: 39

When using FTP for file transfer, how many TCP connections will be established?

- A. 3
- B. 2
- C. 1
- D. 4

Answer: B ([LEAVE A REPLY](#))

NEW QUESTION: 40

As shown in the figure below, the network and switch configuration information are shown in the figure. Which of the following statements is correct? (Multiple choice)

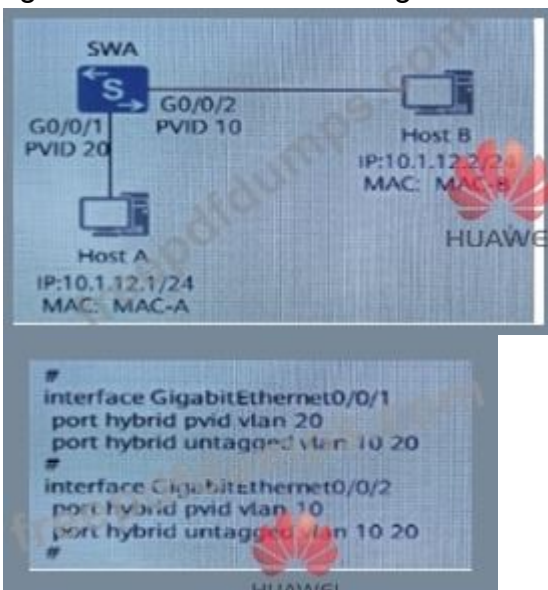

- A. Data frames on the two links do not contain VLAN TAG
- B. Host point and host B cannot ping
- C. Host A and Host B can be pinged
- D. The PVID of the switch GigabitEthernet0/0/1 port is 20

Answer: A,B,D ([LEAVE A REPLY](#))

NEW QUESTION: 41

The G0/0/1 interface configuration information of router A is shown in the figure. Which of the following statements is correct? (Multiple choice)

```

#
acl number 3000
 rule 5 deny 17
 rule 10 deny 89
 rule 15 deny 6
#
interface GigabitEthernet0/0/1
 traffic-filter inbound acl 3000
#
  
```

- A. This interface will not forward received SNMP packets
- B. This interface will not forward received FTP packets
- C. This interface will not forward ICMP packets
- D. This interface can establish OSPF neighbor relationships with other routers

Answer: ([SHOW ANSWER](#))

NEW QUESTION: 42

The switch GO/0/1 port configuration information is shown in the figure. Which VLAN data frame does the switch forward without VLAN TAG?

```

#
interface GigabitEthernet0/0/1
 port link-type trunk
 port trunk pvid vlan 10
 port trunk allow-pass vlan 10 20 30 40
#
  
```

- A. 20
- B. 30
- C. 10
- D. 40

Answer: ([SHOW ANSWER](#))

NEW QUESTION: 43

Which of the following fields does the MPLS header include? (Multiple choice)

- A. Label

- B. EXP
- C. TTL
- D. Tos

Answer: A,B,C ([LEAVE A REPLY](#))

NEW QUESTION: 44

The load sharing mode at both ends of the Eth-Trunk can be inconsistent.

- A. TRUE
- B. FALSE

Answer: B ([LEAVE A REPLY](#))

NEW QUESTION: 45

Regarding the IPv6 address 2031:0000:720C:0000:0000:09E0:839A:130B, which of the following abbreviations is correct?

- A. 2031::720C::9E0:839A:130B
- B. 2031:0:720C:0:0:9E:839A:130B
- C. 2031:0:720C:0:0:9E0:839A:130B
- D. 2031:0:720C::9E0:839A:130B

Answer: D ([LEAVE A REPLY](#))

NEW QUESTION: 46

A certain ACL of the router is in the following rules, rule deny source 192.168.2.0 0.0.0.255 destination 172.16.10.2 0.0.0.0 Which statement is correct?

- A. All TCP packets whose source IP is 192.168.2.1 and destination IP is 172.16.10.2 are configured with this rule.
- B. All TCP packets whose source IP is 172.16.10.2 and destination IP 192.168.2.0 match this rule
- C. All TCP packets whose source IP is 172.16.10.2. Destination IP is 192.168.2.1 match this rule
- D. All TCP packets whose source IP is 192.168.2.1 and destination IP is 172.16.10.1 match this rule

Answer: A ([LEAVE A REPLY](#))

Valid H12-811 Dumps shared by Actual4test.com for Helping Passing H12-811 Exam!
Actual4test.com now offer the **newest H12-811 exam dumps**, the Actual4test.com H12-811 exam **questions have been updated** and **answers have been corrected** get the **newest** Actual4test.com H12-811 dumps with Test Engine here:

https://www.actual4test.com/H12-811_examcollection.html (732 Q&As Dumps, **30%OFF**)

Special Discount: **Freepdfdumps**)

NEW QUESTION: 47

In order to join the wireless network STA needs to obtain wireless network information first. Which of the following messages is used by the STA to actively obtain the SSID information?

- A. Beacon
- B. Discovery
- C. Join
- D. Probe

Answer: ([SHOW ANSWER](#))

NEW QUESTION: 48

In the history of WLAN development, which of the following is not included in the main wireless protocol standards in the primary mobile office era?

- A. 802.11a
- B. 802.11b
- C. 802.11g
- D. 802.11ac

Answer: D ([LEAVE A REPLY](#))

NEW QUESTION: 49

Which of the following attributes cannot be used as a parameter to measure Cost? (Multiple choice)

- A. Hop count
- B. Sysname
- C. Bandwidth
- D. Delay

Answer: ([SHOW ANSWER](#))

NEW QUESTION: 50

A network engineer prompts the following information when entering the command line:

Error: Unrecognized command found at ' ^ ' position. Which of the prompt information is correct?

- A. The input command is incomplete
- B. Input command is not clear
- C. Wrong parameter type
- D. No keyword found

Answer: ([SHOW ANSWER](#))

NEW QUESTION: 51

In the network shown in the figure below, host A logs in to router A through Telnet, and then obtains the configuration file of router B through FTP on the remote interface. How many TCP connections exist on router A at this time?



- A. 4
- B. 2
- C. 1
- D. 3

Answer: D ([LEAVE A REPLY](#))

NEW QUESTION: 52

When Huawei switches allow STP, the priority of the switch is by default:

- A. 32768
- B. 16384
- C. 4096
- D. 8192

Answer: ([SHOW ANSWER](#))

NEW QUESTION: 53

According to the command shown in the figure, which of the following description is correct?
 (Multiple choice)

```
[Huawei-GigabitEthernet0/0/1] port link-type access
[Huawei-GigabitEthernet0/0/1] port default vlan 10

[Huawei-GigabitEthernet0/0/2] port link-type trunk
[Huawei-GigabitEthernet0/0/2] port trunk allow-pass vlan 10
```

- A. The PVID of GigabitEthernet0/0/2 port is 10
- B. The PVID of GigabitEthernet0/0/2 port is 1
- C. The PVID of GigabitEthernet0/0/1 port is 10
- D. The PVID of GigabitEthernet0/0/1 port is 11

Answer: B,C ([LEAVE A REPLY](#))

NEW QUESTION: 54

There is no channel overlap in the 14 available frequency bands in the 2.4GHz frequency band.

- A. False
- B. True

Answer: A ([LEAVE A REPLY](#))

NEW QUESTION: 55

Which fields in the IPv4 header are related to fragmentation? (Multiple Choice)

- A. TTL
- B. Identification
- C. Flags
- D. Fragment Offset

Answer: B,C,D ([LEAVE A REPLY](#))

NEW QUESTION: 56

As shown in the figure below, the wrong statement is:

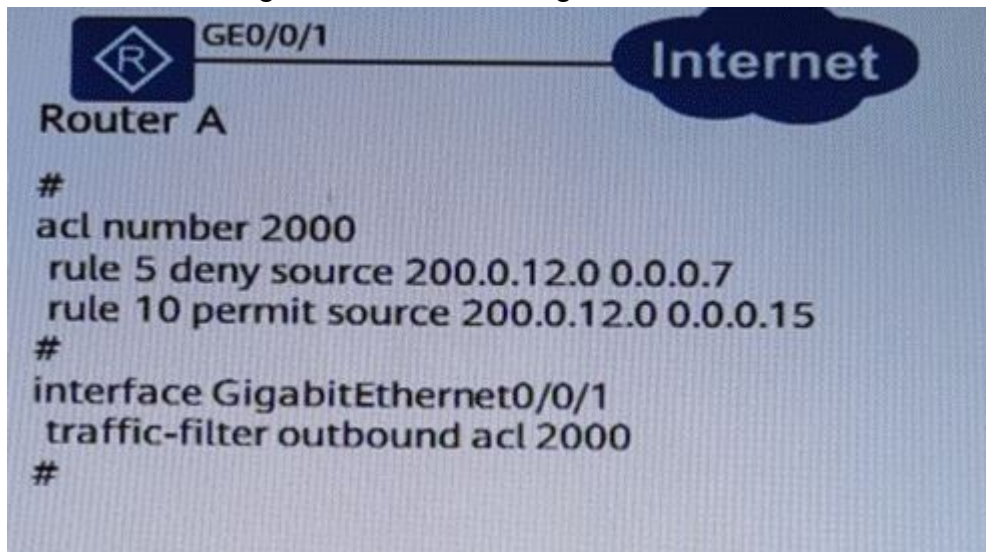

acl number 2000]

rule 5 deny source 200.0.12.00.0.0.7 rule 10permit source200.0.12.00.0.0.15 #

interface GigabitEthernetO/0/1 traffic-filteroutbound acl2000

- A. The host whose source IP address is 200.0.12.4 cannot access the Internet
- B. The host whose source IP address is 200.0.12.6 cannot access the Internet
- C. The host whose source IP address is 200.0.12.2 cannot access the Internet
- D. The host whose source IP address is 200.0.12.8 cannot access the Internet

Answer: D ([LEAVE A REPLY](#))

NEW QUESTION: 57

The configuration information of a router is shown in the figure. Which of the following statements are correct? (Multiple choice)



```

#
aaa
 authentication-scheme default
 authentication-scheme huawei
  authentication-mode radius
 authorization-scheme default
 authorization-scheme huawei
 accounting-scheme default
 domain default
 domain default_admin
 domain huawei
  authentication-scheme huawei
  authorization-scheme huawei
 local-user huawei password cipher 123456
 local-user huawei@huawei password cipher 654321
#

```

- A. Use the username huawei for authentication, the password needs to be 654321
- B. The authentication method adopted by the domain with the domain name huawei is local ID
- C. The authorization method for the domain with the domain name huawei is local authorization
- D. The domain with the domain name huawei does not use the billing plan

Answer: ([SHOW ANSWER](#))

NEW QUESTION: 58

A DHCP server is deployed in the network, but the administrator found that some hosts did not correctly obtain the address specified by the DHCP server. What are the possible reasons?
(Multiple choice)

- A. The address pool of the DHCP server has all been allocated
- B. Some hosts cannot communicate with the DHCP server normally, and the client systems of these hosts automatically generate addresses in the range of 127.254.0.0
- C. Some hosts cannot communicate with the DHCP server normally, and the client systems of these hosts automatically generate addresses in the range of 169.254 0.0
- D. There is another DHCP server in the network that works more efficiently

Answer: ([SHOW ANSWER](#))

NEW QUESTION: 59

If the Proto of a route information in the routing table is OSPF, the priority of this route must be 10.

- A. False
- B. True

Answer: A ([LEAVE A REPLY](#))

NEW QUESTION: 60

The administrator wants to configure a hundred IP address on the G0/0/0 interface of the router, then which of the following addresses is correct?

- A. 145.4.2.55/26
- B. 237.6.1.2/24
- C. 192.168.10.112/30
- D. 127.3.1.4/28

Answer: A ([LEAVE A REPLY](#))

NEW QUESTION: 61

Which field of the ipv6 packet header can be used for QoS?

- A. Payload Length
- B. Traffic Class
- C. Next Header
- D. Version

Answer: B ([LEAVE A REPLY](#))

Valid H12-811 Dumps shared by Actual4test.com for Helping Passing H12-811 Exam!
Actual4test.com now offer the **newest H12-811 exam dumps**, the Actual4test.com H12-811 exam **questions have been updated** and **answers have been corrected** get the **newest** Actual4test.com H12-811 dumps with Test Engine here:

https://www.actual4test.com/H12-811_examcollection.html (732 Q&As Dumps, **30%OFF**)

Special Discount: Freepdfdumps)

NEW QUESTION: 62

In the network shown in the figure, which of the following configurations can realize that host A can access the Internet, but host B can not? (Multiple Choice)

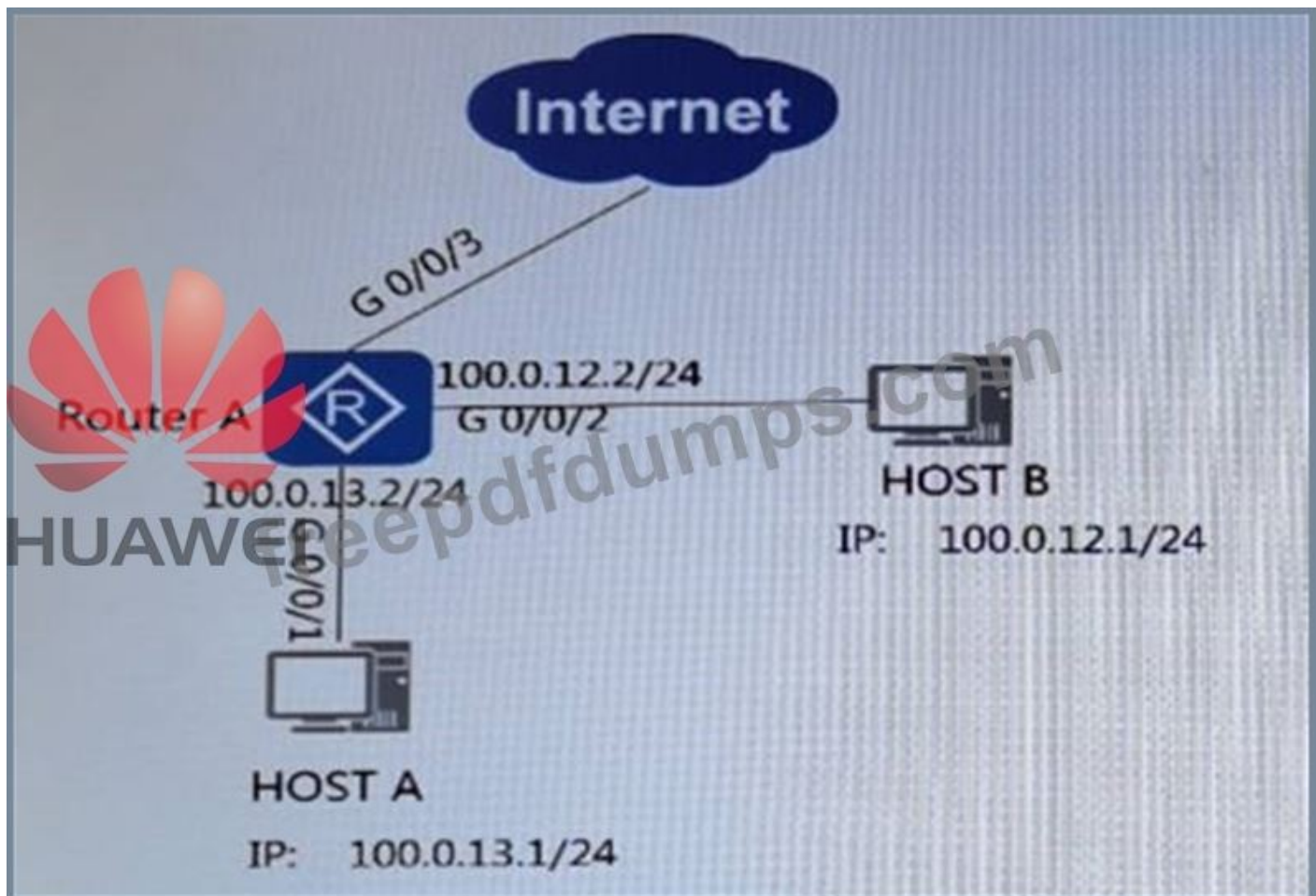

- A. acl number 2000 rule 5 permit source 100.0.12.0 0.0.0.255 rule 10 deny source 100.0.13.0 0.0.0.255 # Interface GigabitEthernet0/0/3 traffic-filter outbound ac1 2000 #
- B. acl number 2000 rule 5 deny source 100.0.12.0 0.0.0.255 rule 10 permit source 100.0.13.0 0.0.0.255 # Interface GigabitEthernet0/0/3 traffic-filter outbound ac1 2000 #
- C. acl number 2000 rule 5 deny source 100.0.12.0 0.0.0.255 rule 10 permit # Interface GigabitEthernet0/0/3 traffic-filter outbound ac1 2000 #
- D. acl number 2000 rule 5 permit source 100.0.12.0 0.0.0.255 rule 10 deny # Interface GigabitEthernet0/0/3 traffic-filter outbound ac1 2000 #

Answer: ([SHOW ANSWER](#))

NEW QUESTION: 63

Which of the following are not open interfaces of Huawei network equipment? (Multiple choice)

- A. NETCONF
- B. JSON
- C. RESTCONF
- D. XML

Answer: B,D ([LEAVE A REPLY](#))

NEW QUESTION: 64

To apply the ACL configured in the figure in Telnet, which of the following statements is correct?

```
#
acl number 2000
 rule 5 deny source 172.16.105.3 0
 rule 10 deny source 172.16.105.4 0
 rule 15 deny source 172.16.105.5 0
 rule 20 permit
#
```

- A. The device with IP address 172.16.105.5 can use Telnet service
- B. The device with IP address 172.16.105.4 can use Telnet service
- C. The device with IP address 172.16.105.3 can use Telnet service
- D. The device with IP address 172.16.105.6 can use Telnet service

Answer: D ([LEAVE A REPLY](#))

NEW QUESTION: 65

All interfaces of the router belong to the same broadcast domain.

- A. False
- B. True

Answer: ([SHOW ANSWER](#)**)**

NEW QUESTION: 66

The two switches shown below have both enabled the STP protocol. An engineer made the following conclusions on this network. Which conclusions do you think are correct? (Multiple choice)

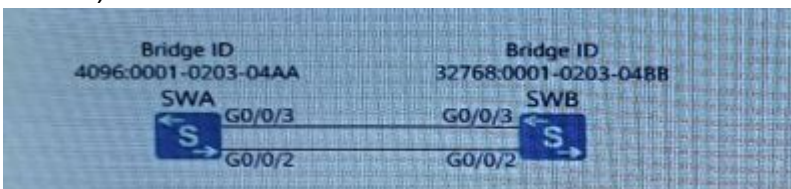

- A. Both ports of SWB are designated ports
- B. G0/0/2 port of SWB is stable in Forwarding state
- C. Both ports of SWA are designated ports
- D. The G0/0/2 port of SWA is stable in Forwarding state
- E. The G0/0/3 port of SWA is stable in Forwarding state

Answer: B,C,D,E ([LEAVE A REPLY](#))

NEW QUESTION: 67

Which extension headers are supported by IPv6 packets? (Multiple choice)

- A. Fragmentation extension header
- B. Destination option extension header
- C. Hop-by-hop option extension header
- D. VLAN extension header

Answer: A,B,C ([LEAVE A REPLY](#))

NEW QUESTION: 68

In the VRP interface, use the command startup saved-configuration backup.cfg. to configure the backup.cfg file for the next startup.

- A. True
- B. False

Answer: A ([LEAVE A REPLY](#))

NEW QUESTION: 69

Which of the following protocols does the RA message used by IPv6 stateless autoconfiguration belong to?

- A. IGMPv6
- B. TCPv6
- C. UDPv6
- D. ICMPv6

Answer: D ([LEAVE A REPLY](#))

NEW QUESTION: 70

Which of the following networks belong to a local area network? (Multiple choice)

- A. Internet
- B. A home network
- C. Broadband Metropolitan Area Network
- D. Office network of a company

Answer: ([SHOW ANSWER](#))

NEW QUESTION: 71

Which of the following port states is not included in the RSTP protocol?

- A. Blocking
- B. Discarding
- C. Forwarding
- D. Learning

Answer: ([SHOW ANSWER](#))

NEW QUESTION: 72

What is the transmission rate of an Eth-Trunk port in manual link aggregation mode related to? (Multiple choice)

- A. Bandwidth of member ports
- B. Number of member ports
- C. If an IP address is configured on the member port
- D. If the member port is on the public or private network

Answer: A,B ([LEAVE A REPLY](#))

NEW QUESTION: 73

As shown in the figure, all four switches run STP, and various parameters adopt default values. If the G0/0/2 port of switch C is blocked and the configuration BPDU cannot be sent through this port, how long will it take for the blocked port in the network to enter the forwarding state?

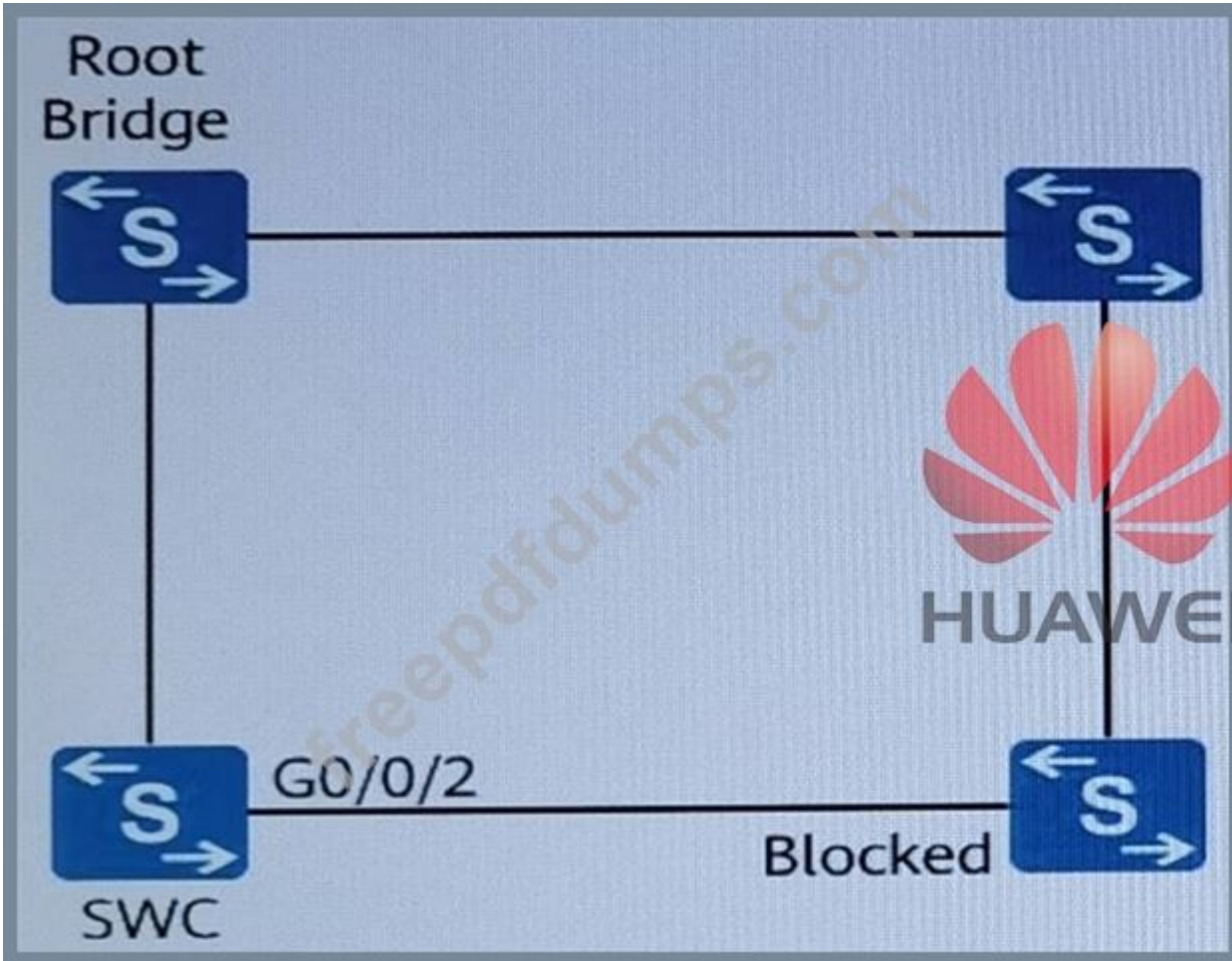

- A. about 50 seconds
- B. about 15 seconds
- C. about 30 seconds
- D. about 3 seconds

Answer: A ([LEAVE A REPLY](#))

NEW QUESTION: 74

In order to implement the FIT AP online, the FIT AP first needs to obtain the IP address of the AC. Which of the following is not included in the method of obtaining the IP address of the AC by the FIT AP?

- A. DHCP Option mode
- B. Static designation method on AP
- C. Multicast mode
- D. Broadcasting method

Answer: D ([LEAVE A REPLY](#))

NEW QUESTION: 75

The IPv6 protocol uses NS and NA packets for duplicate address detection (DAD).

- A. False
- B. True

Answer: B ([LEAVE A REPLY](#))

NEW QUESTION: 76

In the network shown in the figure below, two switches are connected by four links, COPPER refers to electrical interface, and FIBER refers to optical interface. Which of the following two interfaces can achieve link aggregation?

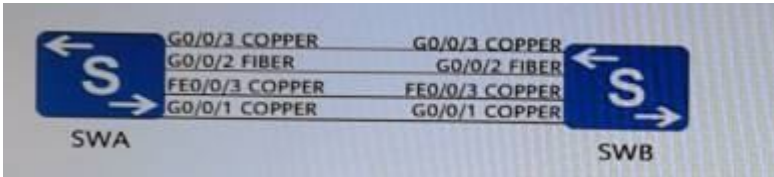

- A. G0/0/3 and FE0/0/3
- B. G0/0/2 and FE0/0/3
- C. G0/0/3 and G0/0/1
- D. G0/0/2 and G0/0/1

Answer: C ([LEAVE A REPLY](#))

Valid H12-811 Dumps shared by Actual4test.com for Helping Passing H12-811 Exam! Actual4test.com now offer the **newest H12-811 exam dumps**, the Actual4test.com H12-811 exam **questions have been updated** and **answers have been corrected** get the **newest** Actual4test.com H12-811 dumps with Test Engine here:

https://www.actual4test.com/H12-811_examcollection.html (732 Q&As Dumps, **30%OFF**)

Special Discount: **Freepdfdumps**)

NEW QUESTION: 77

In the OSI reference model, what can complete end-to-end error detection and flow control?

- A. Data link layer
- B. Physical layer
- C. Network layer
- D. Transport layer

Answer: D ([LEAVE A REPLY](#))

NEW QUESTION: 78

SNMPv1 defines 5 protocol operations.

- A. False
- B. True

Answer: B ([LEAVE A REPLY](#))

NEW QUESTION: 79

Which of the following IPv6 addresses is a multicast address?

- A. 2000 :: 2E0 : FCFF : FEEF : FEC
- B. FC00 :: 2E0 : FCFF : FEEF : FEC
- C. FE80 :: 2E0 : FCFF : FEEF : FEC
- D. FF02 :: 2E0 : FCFF : FEEF : FEC

Answer: D ([LEAVE A REPLY](#))

NEW QUESTION: 80

The Layer 2 networking of WLAN means that the STA uses the AC as its gateway.

- A. False
- B. True

Answer: B ([LEAVE A REPLY](#))

NEW QUESTION: 81

Which of the following IEEE 802.11 standards support operation in the 5GHz frequency band?

(Multiple choice)

- A. 802.11ac
- B. 802.11g
- C. 802.11n
- D. 802.11a

Answer: ([SHOW ANSWER](#))

NEW QUESTION: 82

As shown in the figure below, which of the following statement is correct?

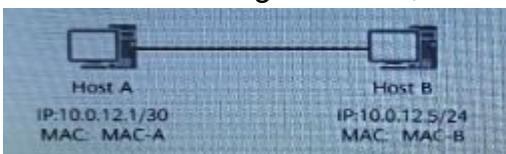

- A. Host A can ping host B
- B. The IP address masks of host A and host B are different, so host A and host B cannot communicate
- C. Only when the masks of host A and host B are set to always, host A and host B can communicate
- D. The broadcast address of host A and host B are the same

Answer: B ([LEAVE A REPLY](#))

NEW QUESTION: 83

Which planes of the following does a network device have? (Multiple choice)

- A. Business plane
- B. Control plane

- C. Management plane
- D. Data plane

Answer: ([SHOW ANSWER](#))

NEW QUESTION: 84

What is the total length of the IPv6 address in bits?

- A. 96
- B. 128
- C. 32
- D. 64

Answer: B ([LEAVE A REPLY](#))

NEW QUESTION: 85

In the network shown in the figure below, if Router A and Router B's loopback 0 communicate through static routing, which command needs to be entered on Router A?

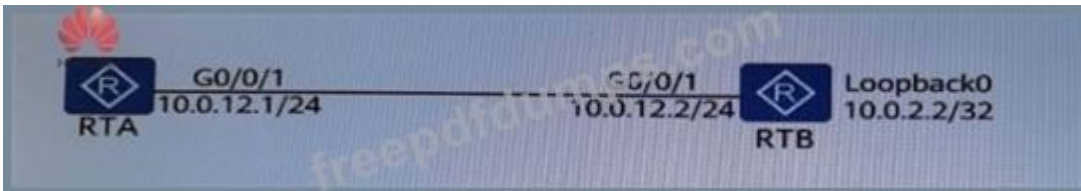

- A. ip route-static 10.0.2.2 255.255.255.255 10.0.12.1
- B. ip route-static 10.0.2.2 255.255.255.255 10.0.12.2
- C. ip route-static 10.0.2.2 0 GigabitEthernet 0/0/0
- D. ip route-static 10.0.2.2 32 GigabitEthernet 0/0/0

Answer: B ([LEAVE A REPLY](#))

NEW QUESTION: 86

In the OSPF broadcast network, which routers will a Dothter router exchange link state information with? (Multiple Choice)

- A. DR Other
- B. BDR
- C. DR
- D. All OSPF neighbors

Answer: ([SHOW ANSWER](#))

NEW QUESTION: 87

Which of the following statements about the default route are correct? (Multiple Choice)

- A. There must be a default route in the routing table of any router
- B. If the destination address of the message cannot match any other routing entries in the routing table, the router will forward the message according to the default route
- C. The default route can only be manually configured by the administrator

D. In the routing table, the default route appears as a route to the network 0.0.0.0 (the mask is also 0.0.0.0)

Answer: B,D ([LEAVE A REPLY](#))

NEW QUESTION: 88

NAPT distinguishes the IP addresses of different users through the protocol numbers in TCP, UDP, or IP packets.

A. False

B. True

Answer: ([SHOW ANSWER](#))

NEW QUESTION: 89

Which of the following description about DD packets and LSA of OSPF is correct? (Multiple choice)

A. The header of an LSA can uniquely identify an LSA

B. DD packet contains detailed information about LSA

C. The DD packet contains only LSA header information

D. LSA header is only a small part of LSA

Answer: A,C,D ([LEAVE A REPLY](#))

NEW QUESTION: 90

Which of the following does not include in VRP system login method?

A. Netstream

B. SSH

C. web

D. Telnet

Answer: A ([LEAVE A REPLY](#))

NEW QUESTION: 91

When the switch port receives a data frame that does not carry VLAN TAG, it must add PVID

A. False

B. True

Answer: B ([LEAVE A REPLY](#))

Valid H12-811 Dumps shared by Actual4test.com for Helping Passing H12-811 Exam!
Actual4test.com now offer the **newest H12-811 exam dumps**, the Actual4test.com H12-811 exam **questions have been updated** and **answers have been corrected** get the **newest** Actual4test.com H12-811 dumps with Test Engine here:

Special Discount: **Freepdfdumps**)

NEW QUESTION: 92

By default, network devices running SNMPv2c protocol use which of the following port numbers to send trap messages to the network management system?

- A. 161
- B. 162
- C. 17
- D. 6

Answer: B ([LEAVE A REPLY](#))

NEW QUESTION: 93

The router running the OSPF protocol reaches the FULL state first, and then synchronizes the LSDB.

- A. False
- B. True

Answer: A ([LEAVE A REPLY](#))

NEW QUESTION: 94

In order to realize the network layer function on VLANIF interface, what need to be configured on VLANIF interface? (Multiple choice)

- A. IP prefix
- B. Subnet mask
- C. MAC address
- D. IP address

Answer: B,D ([LEAVE A REPLY](#))

NEW QUESTION: 95

When deploying ACL on Huawei devices, which of the following description is correct? (Multiple choice)

- A. ACL cannot be used to filter OSPF traffic, because OSPF traffic does not use UDP protocol encapsulation
- B. ACL can match the TCP/UDP port number of the message, and can specify the range of port numbers
- C. When ACL defines rules, it can only proceed in the order of 10, 20, and 30
- D. The same ACL can be called under multiple interfaces
- E. When calling ACL under the interface, it can only be applied to the outbound direction

Answer: B,D ([LEAVE A REPLY](#))

NEW QUESTION: 96

In the network shown in the figure below, the host has an ARP cache, and host A sends a packet to host B.

What are the destination MAC and destination IP of this packet?

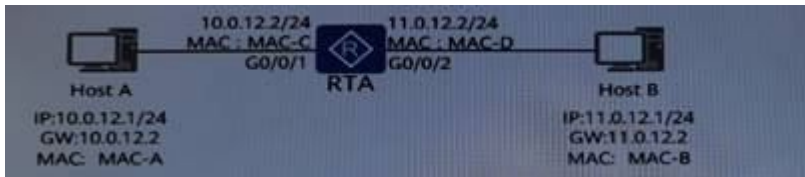

A. MAC-D, 11.0.12.1

B. MAC-C, 10.0.12.2

C. MAC-A, 11.0.12.1

D. MAC-B, 11.0.12.1

Answer: A ([LEAVE A REPLY](#))

NEW QUESTION: 97

In the network shown in the figure below, all routers run OSPF protocol. Above the link is the value of the Cost value, then the path for RTA to reach the network 10.0.0.0/8 is:

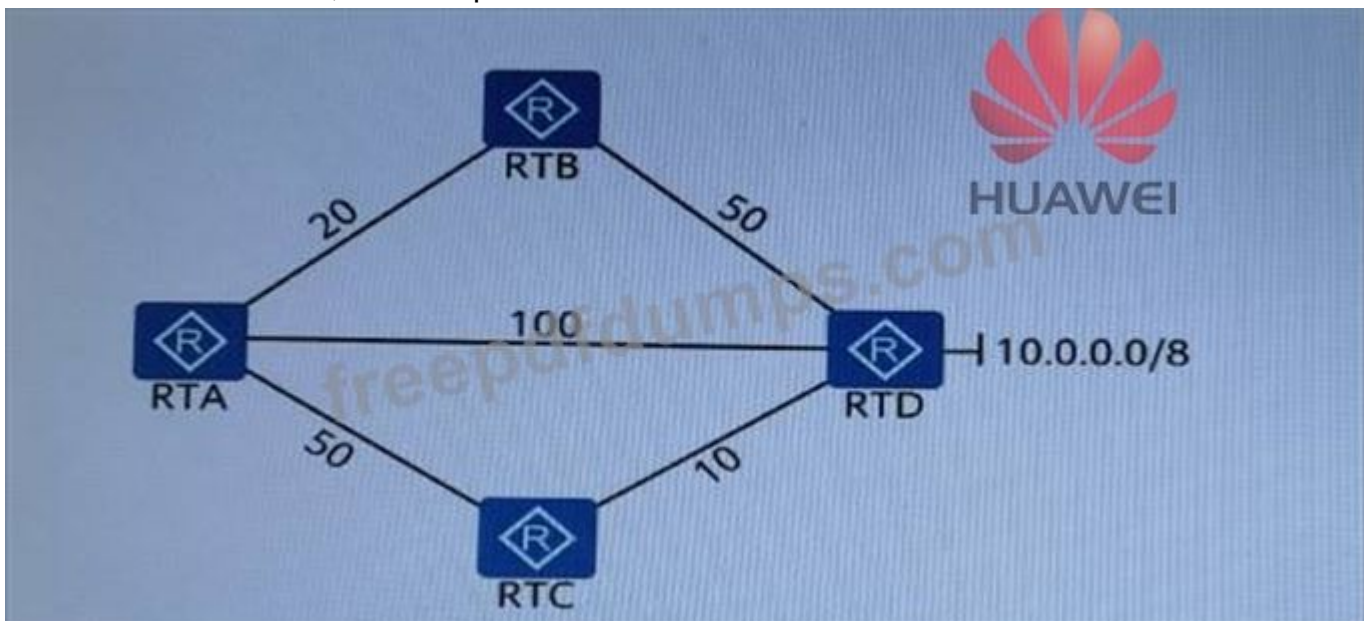

A. A-D

B. RTA cannot reach 10.0.0.0/8

C. A-B-D

D. A-C-D

Answer: ([SHOW ANSWER](#))

NEW QUESTION: 98

Which of the following descriptions about the switch is wrong?

A. Switches are generally used as network export equipment

B. Switches generally work at the data link layer

C. The switch can provide network access services for terminal equipment (PC, Server)

D. The switch can complete the exchange of data frames

Answer: A ([LEAVE A REPLY](#))

NEW QUESTION: 99

By default, the bridge priority of Huawei switches is 32768.

- A. False
- B. True

Answer: B ([LEAVE A REPLY](#))

NEW QUESTION: 100

Which of the following levels is not a common network level in mid-sized campus network architecture?

- A. Convergence layer
- B. Access layer
- C. Network layer
- D. Core layer

Answer: ([SHOW ANSWER](#))

NEW QUESTION: 101

If during the PPP authentication process, the authenticatee sends the wrong user name and password to the authenticator, what type of message will the authenticator send to the authenticatee?

- A. Authenticate-Reply
- B. Authenticate-Reject
- C. Authenticate-Nak
- D. Authenticate-Ack

Answer: C ([LEAVE A REPLY](#))

NEW QUESTION: 102

When the switch port sends a data frame carrying the same VLAN TAG and PVID, it must strip the VLAN TAG and forward it.

- A. False
- B. True

Answer: ([SHOW ANSWER](#))

NEW QUESTION: 103

In the VRP interface, use the command startup saved-configuration backup.cfg to configure the startup.cfg file for the next startup.

- A. TURE
- B. FALSE

Answer: A ([LEAVE A REPLY](#))

NEW QUESTION: 104

As shown in the network below, all switches enable STP protocol. Disable SWA's G0/0/2 port configuration BPDU sending function, SWC G0/0/1 re-converges to become the root port, about this process, which of the following statements are correct? (Multiple Choice)

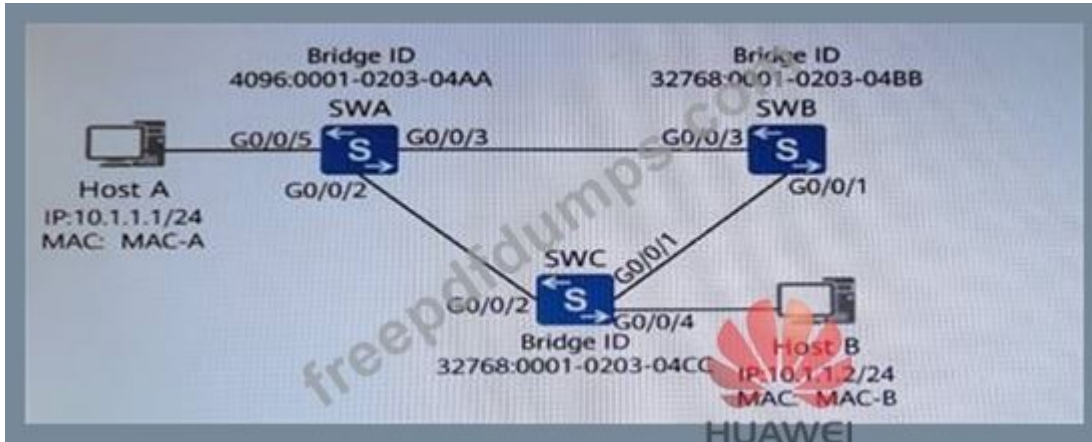

- A. SWB forwards TCN BPDU to SWA
- B. SWB sends configuration BPDU with TCA set to SWC
- C. SWA sends configuration BPDU with TC set
- D. SWC sends TCN BPDU message to SWB

Answer: A,B,C,D ([LEAVE A REPLY](#))

NEW QUESTION: 105

Which WLAN security policies support the link authentication method of Open mode? (Multiple Choice)

- A. WPA2-802.IX
- B. WEP
- C. WPA2-PSK
- D. WPA

Answer: A,B,D ([LEAVE A REPLY](#))

NEW QUESTION: 106

Which of the following statement about static routing in Huawei equipment is wrong?

- A. The cost value (Cost) of the static route cannot be modified.
- B. The range of the static route priority value is 1-255
- C. The default value of the static route priority is 60
- D. When the priority of the static route is 0, the route will definitely be preferred.

Answer: B ([LEAVE A REPLY](#))

Valid H12-811 Dumps shared by Actual4test.com for Helping Passing H12-811 Exam!
Actual4test.com now offer the **newest H12-811 exam dumps**, the Actual4test.com H12-811 exam **questions have been updated** and **answers have been corrected** get the **newest**

Actual4test.com H12-811 dumps with Test Engine here:

https://www.actual4test.com/H12-811_examcollection.html (732 Q&As Dumps, **30%OFF**

Special Discount: Freepdfdumps)

NEW QUESTION: 107

A device has been configured to complete the Telnet configuration. The device login address is 10.1.1.10. The Telnet user name is admin and the password is Huawei@123. Which of the following is the correct way to log in to this device using telnetlib?

- A. telnetlib.Telnet (10.1.1.0,23,admin,Huawei@123)
- B. telnetlib.Telnet (10.1.1.0,admin)
- C. telnetlib.Telnet (10.1.1.0,23, Huawei@123)
- D. telnetlib.Telnet (10.1.1.0)

Answer: A ([LEAVE A REPLY](#))

NEW QUESTION: 108

On Huawei switches, you can use the command vlan batch to create multiple VLANs in batches, simplifying the configuration process.

- A. True
- B. False

Answer: A ([LEAVE A REPLY](#))

NEW QUESTION: 109

What is the maximum negotiation rate supported by the IEEE 802.11g standard?

- A. 300Mbps
- B. 150Mbps
- C. 1200Mbps
- D. 54Kbps

Answer: D ([LEAVE A REPLY](#))

NEW QUESTION: 110

The output information of a certain device is shown in the figure. Which of the following statements is correct? (Multiple Choice)

```
<Huawe1>display interface G1gabitEthernet 0/0/0
```

```
G1gabi tEthernet0/0/0 current state : UP
```

```
Line protocol current state : UP
```

```
Route Port, The Maximum Transmit Unit is 1000
```

```
Internet Address is 10.0.12.2/24
```

```
IP Sending Frames' Format is PRTFMT ETENT_2.Hardware address is 00e0- fc22- 4fff
```

```
Port Mode: FORCE COPPER
```

```
Speed : 100.Loopback: NONE
```

```
Duplex: FULL,Negotiation: DISABLE
```

Md1 : AUTO

Last 300 seconds input rate 24 bits/sec, 0 packets/sec

Last 300 seconds output rate 24 bits/sec, 0 packets/sec

- A. The MTU value of this interface is 1000
- B. The MAC address of the interface is 00e0-fc22-4fff
- C. The working rate of this interface is 1Gbps
- D. The IP address of the interface is 10.0.12.2/24

Answer: A,B,D ([LEAVE A REPLY](#))

NEW QUESTION: 111

When using the FTP protocol to upgrade the router software, which of the following transmission mode should be selected?

- A. Byte mode
- B. Stream byte mode
- C. Binary mode
- D. Text mode

Answer: ([SHOW ANSWER](#))

NEW QUESTION: 112

On the VRP operating platform, what is the command to display the current interface configuration in the interface view?

- A. display users
- B. display version
- C. display ip interfacebrief
- D. display this

Answer: A ([LEAVE A REPLY](#))

NEW QUESTION: 113

Which of the following characteristics does the OSPF protocol have? (Multiple Choice)

- A. Easy to produce routing loops
- B. Calculate the shortest path by number
- C. Support the division of areas
- D. Trigger an update

Answer: C,D ([LEAVE A REPLY](#))

NEW QUESTION: 114

Which state does the OSPF protocol use to indicate that the adjacency relationship has been established?

- A. Attempt
- B. Full
- C. 2-way

D. Down

Answer: ([SHOW ANSWER](#))

NEW QUESTION: 115

Switch stacking supports more than two devices. Through stacking, multiple switches can be grouped into one logical device.

A. False

B. True

Answer: ([SHOW ANSWER](#))

NEW QUESTION: 116

When two OSPF routers form a 2-WAY neighbor relationship, the LSDB has been synchronized.

A. True

B. False

Answer: B ([LEAVE A REPLY](#))

NEW QUESTION: 117

Hybrid port can be connected to user host and other switches.

A. False

B. True

Answer: B ([LEAVE A REPLY](#))

NEW QUESTION: 118

The switch becomes a logical switch after stacking and clustering, and Eth-Trunk across physical devices can be deployed to improve network reliability.

A. True

B. False

Answer: A ([LEAVE A REPLY](#))

NEW QUESTION: 119

Regarding the control plane of the device, which of the following statements is correct? (Multiple choice)

A. The control plane provides equipment monitoring capabilities

B. The control plane is responsible for generating the IP routing table

C. The control plane is responsible for directing data forwarding

D. The control plane is responsible for the interaction of routing protocols between devices

Answer: A,B,D ([LEAVE A REPLY](#))

NEW QUESTION: 120

If the broadcast address of a network is 172.16.1.255, what might its network address be?

A. 172.16.1.128

- B. 172.16.1.253
- C. 172.16.1.1
- D. 172.16.2.0

Answer: A ([LEAVE A REPLY](#))

NEW QUESTION: 121

MIB (Management Information Base) is a virtual database that exists only in NMS.

- A. False
- B. True

Answer: ([SHOW ANSWER](#))

Valid H12-811 Dumps shared by Actual4test.com for Helping Passing H12-811 Exam!
Actual4test.com now offer the **newest H12-811 exam dumps**, the Actual4test.com H12-811 exam **questions have been updated** and **answers have been corrected** get the **newest** Actual4test.com H12-811 dumps with Test Engine here:

https://www.actual4test.com/H12-811_examcollection.html (732 Q&As Dumps, **30%OFF**)

Special Discount: [Freepdfdumps](#))

NEW QUESTION: 122

Which of the following are not the characteristics of a small-sized campus network?

- A. Simple network requirements
- B. Simple network level
- C. Wide coverage
- D. Fewer users

Answer: C ([LEAVE A REPLY](#))

NEW QUESTION: 123

On Huawei routers, what is the default value of the OSPF protocol internal routing priority?

- A. 0
- B. 20
- C. 30
- D. 10

Answer: D ([LEAVE A REPLY](#))

NEW QUESTION: 124

Which of the following advantages does router-on-a-stick achieve inter-VLAN routing intercommunication?

- A. Reduce routing table entries
- B. Reduce the number of link connections

- C. Reduce the use of IP addresses
- D. Reduce the number of equipment

Answer: B ([LEAVE A REPLY](#))

NEW QUESTION: 125

What is the full name of the general routing platform VRP?

- A. Virtual Routing Platform
- B. Versatile Routing Platform
- C. Versatile Redundancy Platform
- D. Versatile Routing Protocol

Answer: ([SHOW ANSWER](#))

NEW QUESTION: 126

In the campus network, network reliability can be improved by using link aggregation and stacking technology.

- A. True
- B. False

Answer: A ([LEAVE A REPLY](#))

NEW QUESTION: 127

The administrator cannot log in to the Huawei router through Telnet, but other administrators can log in normally, so which of the following are the possible reasons? (Multiple Choice)

- A. The Te1net service of the AR2200 router has been disabled
- B. The administrator user account has been deleted
- C. The administrator user account has been disabled
- D. The authority level of the administrator user account has been modified to 0

Answer: ([SHOW ANSWER](#))

NEW QUESTION: 128

In the RSTP standard, in order to improve the convergence speed, the port that the switch is directly connected to the terminal can be defined as ().

- A. Root port
- B. Edge port
- C. Backup port
- D. Fast port

Answer: B ([LEAVE A REPLY](#))

NEW QUESTION: 129

Which of the following statements about Trunk port and Access port are correct?

- A. Trunk ports can only send untagged frames
- B. Access port can only send untagged frames

- C. Trunk ports can only send tagged frames
- D. Access port can only send tagged frames

Answer: B ([LEAVE A REPLY](#))

NEW QUESTION: 130

What is the data link layer MAC address of each VAP on the AP?

- A. BSS
- B. ESS
- C. BSSID
- D. SSID

Answer: C ([LEAVE A REPLY](#))

NEW QUESTION: 131

Which of the following SNMP packets are sent to the NMS by the Agent on the managed device?

- A. Set-Request
- B. Get-Next-Request
- C. Get-Request
- D. Response

Answer: ([SHOW ANSWER](#))

NEW QUESTION: 132

What is the coverage area of an AP in WLAN?

- A. SSID
- B. BSS
- C. ESS
- D. BSSID

Answer: ([SHOW ANSWER](#))

NEW QUESTION: 133

Which of the following descriptions about firewalls is wrong?

- A. The firewall cannot achieve network address translation
- B. Firewall can isolate networks with different security levels
- C. Firewall can realize user identity authentication
- D. Firewall can realize access control between different networks

Answer: A ([LEAVE A REPLY](#))

NEW QUESTION: 134

Which of the following parameters is not included in the configuration BPDU of the STP protocol?

- A. Root ID
- B. VLAN ID
- C. Port ID

D. Bridge ID

Answer: ([SHOW ANSWER](#))

NEW QUESTION: 135

On the switch, which VLANs can be deleted by using the undo command? (Multiple choice)

A. vlan 1

B. vlan 2

C. vlan 1024

D. vlan 4094

Answer: ([SHOW ANSWER](#))

NEW QUESTION: 136

In the network as shown in the figure below, the host has an ARP cache. Which of the following statements is correct? (Multiple Choice)



A. The router needs to be configured with static routing, otherwise host A and host B cannot communicate in both directions

B. Host A and Host B can communicate in both directions

C. The following entries may exist in the ARP cache of host A, 10.0.12.2 MAC-C

D. The following entries exist in the ARP cache of host A 11.0.12.1 MAC-B

Answer: B,C ([LEAVE A REPLY](#))

Valid H12-811 Dumps shared by Actual4test.com for Helping Passing H12-811 Exam! Actual4test.com now offer the **newest H12-811 exam dumps**, the Actual4test.com H12-811 exam **questions have been updated** and **answers have been corrected** get the **newest** Actual4test.com H12-811 dumps with Test Engine here:

https://www.actual4test.com/H12-811_examcollection.html (732 Q&As Dumps, **30%OFF**)

Special Discount: [Freepdfdumps](#))

NEW QUESTION: 137

Using a traditional landline to make calls is a way of network communication.

A. True

B. False

Answer: ([SHOW ANSWER](#))

NEW QUESTION: 138

Which of the following port states does the RSTP protocol include? (Multiple choice)

- A. Forwarding
- B. Listening
- C. Discarding
- D. Learning

Answer: A,C,D ([LEAVE A REPLY](#))

NEW QUESTION: 139

What is the number range of the Layer 2 ACL?

- A. 6000 ~ 6031
- B. 4000 ~ 4999
- C. 2000-2999
- D. 3000-3999

Answer: B ([LEAVE A REPLY](#))

NEW QUESTION: 140

Which of the following are related to the purpose of encapsulation and decapsulation? (Multiple choice)

- A. Interworking between different networks
- B. Encapsulation and decapsulation are important steps to realize different protocol functions
- C. Shorten the length of the message
- D. Encapsulation and decapsulation can complete network fault location

Answer: A,B ([LEAVE A REPLY](#))

NEW QUESTION: 141

How to enter the view of OSPF area 0 in the vrp operating system? (Multiple choice)

- A. [Huawei] ospf area 0
- B. [Huawei-ospf-1] area 0
- C. [Huawei-ospf-1] area 0.0.0.0
- D. [Huawei-ospf-1] area 0 enabel

Answer: B,C ([LEAVE A REPLY](#))

NEW QUESTION: 142

On Huawei AR G3 routers, what is the -i parameter of the Ping command in VRP used to set?

- A. Interface for sending Echo Request messages
- B. Interface for receiving Echo Reply messages
- C. The destination IP address of the Echo Reply message
- D. The source IP address of the Echo Request message

Answer: ([SHOW ANSWER](#))

NEW QUESTION: 143

Which of the following description about the Layer 2 Ethernet switch is incorrect?

- A. Layer 2 Ethernet switches work at the data link layer
- B. It is necessary to make certain modifications to the layer 3 header of the forwarded message, and then forward it
- C. Able to learn MAC address
- D. Forward according to the Layer 2 header information of the Ethernet frame

Answer: B ([LEAVE A REPLY](#))

NEW QUESTION: 144

To query the configuration information of the device's OSPF protocol, which of the following commands can be used? (Multiple Choice)

- A. display ospf peer
- B. display current-configuration
- C. display ip routing-table
- D. Enter the command "display this" in the OSPF protocol view

Answer: (SHOW ANSWER)

NEW QUESTION: 145

The configuration information of a certain port of the switch is shown in the figure. Which of the following statements is wrong?

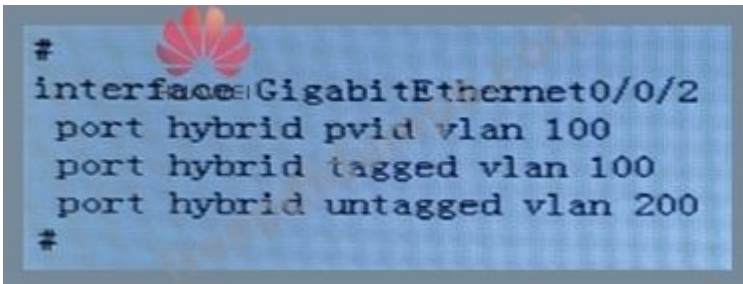

```
#
interface GigabitEthernet0/0/2
 port hybrid pvid vlan 100
 port hybrid tagged vlan 100
 port hybrid untagged vlan 200
#
```

- A. If the VLAN TAG carried in the data frame is 200, the switch strips off the VLAN TAG
- B. The port type is Hybrid
- C. If the port receives a data frame without VLAN TAG, the switch needs to add VLAN TAG 100
- D. If the VLAN TAG carried in the data frame is 100, the switch will strip off the VLAN TAG and send it out

Answer: D ([LEAVE A REPLY](#))

NEW QUESTION: 146

What is the destination IP address of the DHCP DISCOVER message?

- A. 255.255.255.255
- B. 127.0.0.1
- C. 224.0.0.2
- D. 224.0.0.1

Answer: A ([LEAVE A REPLY](#))

NEW QUESTION: 147

As shown in the figure below, router A has Telnet router B through IP address 10.0.12.2. In the current interface, which of the following operations will cause the Telnet session of Router A and Router B to be interrupted? (Multiple Choice)

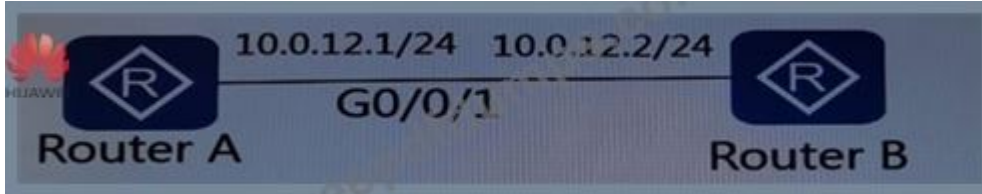

- A. Enable OSPF protocol under G0/0/1 interface
- B. Modify the IP address of G0/0/1 interface
- C. Configure static routing
- D. Close G0/0/1 interface

Answer: ([SHOW ANSWER](#))

NEW QUESTION: 148

What is the port number used by the FTP protocol control plane?

- A. 22
- B. 23
- C. 24
- D. 21

Answer: ([SHOW ANSWER](#))

NEW QUESTION: 149

Which of the following descriptions of OSPF areas are correct? (Multiple choice)

- A. The number of the backbone area cannot be 2
- B. The number range of the area is from 0.0.0.0 to 255.255.255.255
- C. Before configuring the OSPF area, an IP address must be configured for the loopback interface of the router
- D. All networks should be declared in zone 0

Answer: A,B ([LEAVE A REPLY](#))

NEW QUESTION: 150

The device port running STP protocol is in Forwarding state. Which of the following statements is correct?

- A. The port not only does not process BPDU packets, but also does not forward user traffic.
- B. The port only receives and processes BPDUs, and does not forward user traffic.
- C. The port will build a MAC address table based on the received user traffic, but does not forward user traffic.
- D. The port not only forwards user traffic but also processes BPDU packets.

Answer: D ([LEAVE A REPLY](#))

NEW QUESTION: 151

The output information of the link aggregation port of a certain switch is as follows. If you want to delete Eth-Trunk 1, which of the following commands is correct?

```
<SW1>display interface Eth-Trunk 1
Eth-Trunk1 current state : UP
Line protocol current state : UP
Description:
Switch Port, PVID : 1, Hash arithmetic : According to SIP-XOR-DIP, Maximal BW:
2G, Current BW: 2G, The Maximum Frame Length is 9216
IP Sending Frames' Format is PKTFMT_ETHNT_2, Hardware address is 4c1f-ccb0-73d7
Current system time: 2019-02-28 10:28:09-08:00
Input bandwidth utilization : 0%
Output bandwidth utilization : 0%

-----
PortName                Status    Weight
-----
GigabitEthernet0/0/1    UP        1
GigabitEthernet0/0/2    UP        1
-----

The Number of Ports in Trunk : 2
The Number of UP Ports in Trunk : 2
```

- A. `inte GigabitEthernet 0./0/2 Undo eth-trunk Quit Undo interface eth-trunk 1`
- B. `inte GigabitEthernet 0./0/1 Undo eth-trunk Quit Undo interface eth-trunk 1`
- C. `undo interface Eth-trunk 1`
- D. `inte GigabitEthernet 0./0/1 Undo eth-trunk Quit inte GigabitEthernet 0./0/2 Undo eth-trunk Quit`

Answer: C (LEAVE A REPLY)

Valid H12-811 Dumps shared by Actual4test.com for Helping Passing H12-811 Exam! Actual4test.com now offer the **newest H12-811 exam dumps**, the Actual4test.com H12-811 exam **questions have been updated** and **answers have been corrected** get the **newest** Actual4test.com H12-811 dumps with Test Engine here:

https://www.actual4test.com/H12-811_examcollection.html (732 Q&As Dumps, **30%OFF**

Special Discount: Freepdfdumps)

NEW QUESTION: 152

In the network shown in the figure, which of the following description is correct?

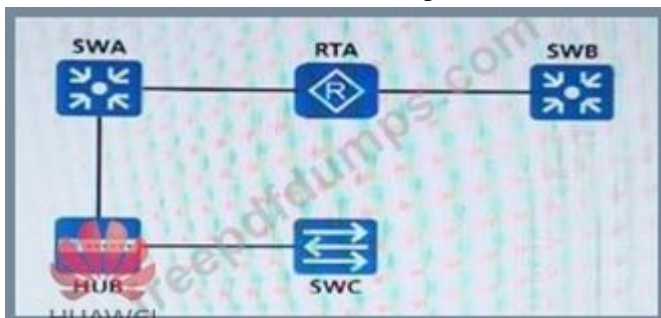

- A. The network between SWA and SWC is the same conflict domain

- B. The network between RTA and SWC is the same conflict domain
- C. The network between SWA and SWC is the same broadcast domain
- D. The network between SWA and SWB is the same broadcast domain

Answer: A ([LEAVE A REPLY](#))

NEW QUESTION: 153

Which of the following options are configured in a Layer 2 ACL? (Multiple choices)

- A. rule 20 permit source-mac 0203-0405-0607
- B. rule 25 permit source 192.168.1.1 0.0.0.0
- C. rule 10 permit 12-protoco1 arp
- D. rule 15 permit vlan-id 100

Answer: A,D ([LEAVE A REPLY](#))

NEW QUESTION: 154

The IPv6 address 2001: ABEF: 224E: FFE2: BCC0: CD00: DDBE: 8D58 cannot be abbreviated.

- A. False
- B. True

Answer: ([SHOW ANSWER](#))

NEW QUESTION: 155

For the description of the PPP link establishment process, which of the following statement is wrong?

- A. The Dead phase is also called the physical layer unavailable phase. When the two ends of the communication detect that the physical line is activated, they will migrate from the Dead phase to the Establish phase, which is the link establishment phase.
- B. PPP link supports half-duplex and full-duplex modes
- C. In the Establish phase, the PPP link performs LCP parameter negotiation. The negotiation content includes the maximum receiving unit MRU, authentication method, magic word and other options.
- D. In the Network phase, the PPP link performs NCP negotiation. Select and configure a network layer protocol through NCP negotiation, and negotiate network layer parameters
- E. After the NCP negotiation is successful, the PPP link will maintain the communication state and enter the Terminate phase.

Answer: E ([LEAVE A REPLY](#))

NEW QUESTION: 156

If the broadcast address of a network is 172.16.1.255, then what may its network address be?

- A. 172.16.2.0
- B. 172.86.1.253
- C. 172.16.1.128
- D. 172.16.1.1

Answer: ([SHOW ANSWER](#))

NEW QUESTION: 157

Which of the following advantages does the router-on-a-stick approach achieve routing intercommunication between VLANs?

- A. Reduce routing table entries
- B. Reduce the number of equipment
- C. Reduce the use of IP addresses
- D. Reduce the number of chain connections

Answer: D ([LEAVE A REPLY](#))

NEW QUESTION: 158

Which statement are correct about the shortcut keys of the VRP operating platform? (Multiple choice)

- A. TAB prompts the most recently entered command
- B. CTRL+Z back to user view
- C. The left cursor key (<) moves the cursor to the left position.
- D. CTRL+C to stop the current command

Answer: B,C,D ([LEAVE A REPLY](#))

NEW QUESTION: 159

Which of the following types of addresses is not included in IPv6 addresses?

- A. Multicast address
- B. Broadcast address
- C. Anycast address
- D. Unicast address

Answer: ([SHOW ANSWER](#))

NEW QUESTION: 160

The MAC address table of existing switches is shown in the figure. Which of the following statement is correct?

```

<Huawei>display mac-address
MAC address table of slot 0:
-----
MAC Address      VLAN/      PEVLAN CEVLAN Port      Type      LSP/LSR-ID
                  VSI/SI
-----
5489-9811-0b49  1          -      -      Eth0/0/3      static    -
-----
Total matching items on slot 0 displayed = 1
MAC address table of slot 0:
-----
MAC Address      VLAN/      PEVLAN CEVLAN Port      Type      LSP/LSR-ID
                  VSI/SI
-----
5489-989d-1d30  1          -      -      Eth0/0/1      dynamic   0/-
5489-9885-18a8  1          -      -      Eth0/0/2      dynamic   0/-
-----
Total matching items on slot 0 displayed = 2

```

- A. The MAC address 5489-989d-1d30 is manually configured by the administrator
- B. After the switch restarts, all MAC addresses need to be relearned
- C. The MAC address 5489-9811-0b49 is manually configured by the administrator
- D. The MAC address 5489-9885-18a8 is manually configured by the administrator

Answer: C ([LEAVE A REPLY](#))

NEW QUESTION: 161

UDP cannot guarantee the reliability of data transmission, and does not provide functions such as message sequencing and flow control. It is suitable for flows with low transmission reliability requirements but high transmission speed and delay requirements.

- A. False
- B. True

Answer: B ([LEAVE A REPLY](#))

Valid H12-811 Dumps shared by Actual4test.com for Helping Passing H12-811 Exam! Actual4test.com now offer the **newest H12-811 exam dumps**, the Actual4test.com H12-811 exam **questions have been updated** and **answers have been corrected** get the **newest** Actual4test.com H12-811 dumps with Test Engine here:

https://www.actual4test.com/H12-811_examcollection.html (732 Q&As Dumps, **30%OFF**)

Special Discount: [Freepdfdumps](#))